

Urband[®]

Technical Guide



www.Urband.com

Table of Contents

Dismantling and assembling an Urband frame	Pages 2-5
Frame specifications	Page 6
Glazing recommendations	Page 6



Dismantling the temples

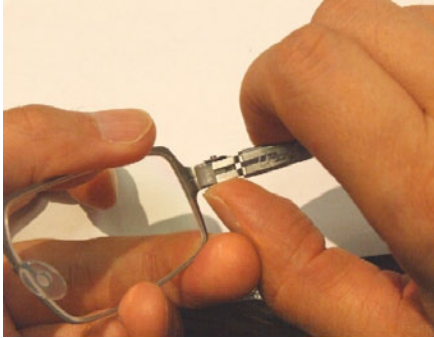

1. Position your thumb below the extension piece as shown in the picture.

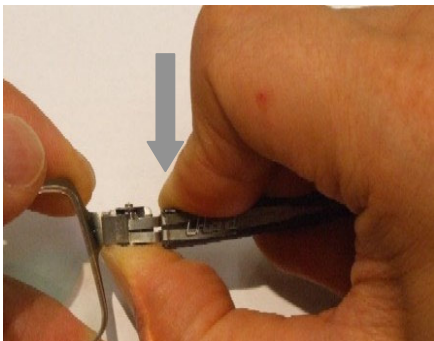

2. Press the top of the temple to take out the top pin from the pin holder.

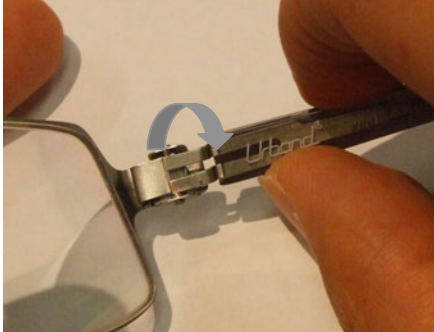

3. Once the pin is out of the pin holder, twist the temple to separate it from the front.

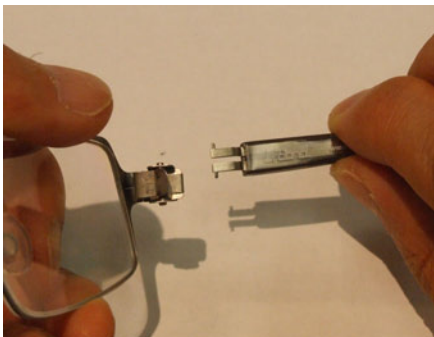

4. Once the temple is separated from the front, the S-clip appears.

Removing the S-clip

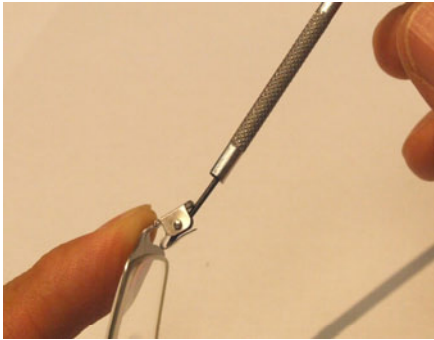

5. Use a screwdriver as a lever to slightly open the S-clip (open no more than 30 degrees).

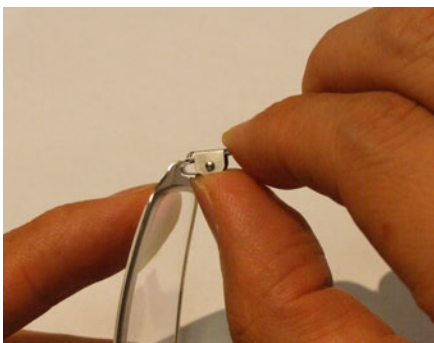

6. Simply push the S-clip out in order to release the two small hooks.

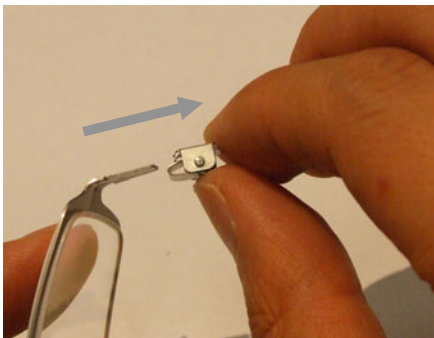

7. Slide the S-clip out as shown in the picture. You will now be able to open the front to insert or remove the lenses (Refer to the end of the guide for glazing recommendations).

Assembling the S-clip

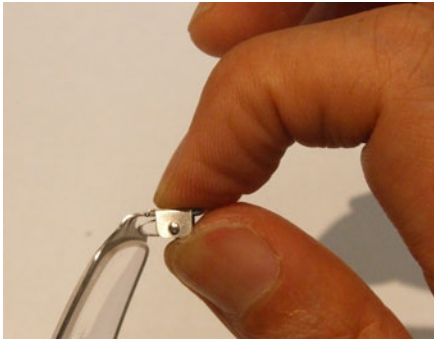

8. Once the prescription lens have been securely attached to the frame front, slide back the S-Clip. Fix the two hooks into the slots to close the front.



9. Insert a plier into the middle of the S-clip (as shown in the picture) to compress the S-clip.



CAUTION

DO NOT FLATTEN THE ENTIRE S-CLIP.



CAUTION

CLAMPING THE ENTIRE S-CLIP WILL CAUSE DAMAGE TO THE S-CLIP



10. Press the S-clip into the extension piece to secure it to the extension piece.

Re-Assembling the temples

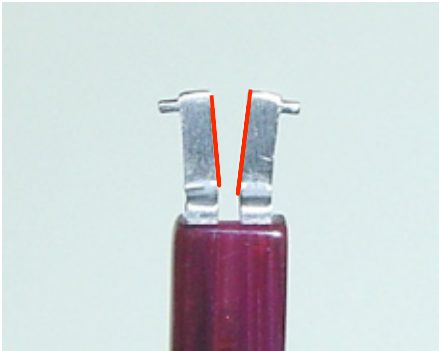

11. Before to put back the temples, please get sure that the two metal pieces form a « V » shape as shown on the picture.



12. If the two metal pieces do not form a "V" shape use flat pliers in order to separate the two metal pieces and adjust it to form a "V" as shown on the picture.

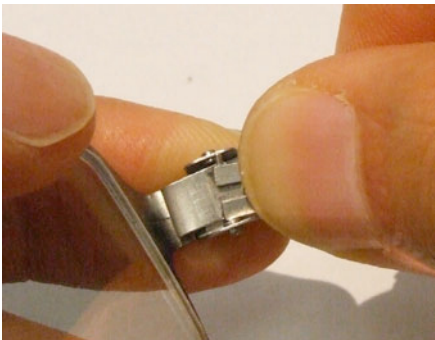

13. Using the bottom pin, press into the S-clip and insert the bottom pin into its pin holder.

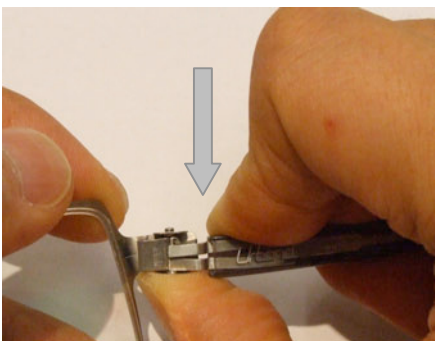

14. Press the top of the temple to insert the second pin into the top pin holder. It is easier if your thumb is below the extension piece of the frame.

Frame Specifications

1. Front in BETA TITANIUM
2. Thickness of the Front : 0.6 mm
3. Front Base :4
4. Temple Core in Stainless steel
5. Temple Tips in ACETATE
6. S-Clip made from Surgical Stainless steel
7. 20° Flexible hinges

** In our continuous pursuit of perfection, Urband reserves the right to change the above specifications without notice.*

Glazing Recommendations

Lenses

Recommended Lenses

1. MR8, Trivex or PNX.
2. Organic lenses of 1.6 or 1.67 indexes. Avoid 1.5 and 1.74 index.
3. Pre-calibrated.
4. Polycarbonate.

Glazing

1. Lens thickness: Minimum 2.2mm, recommended 2.5mm.
2. Depth of groove: 0.45 to 0.6 mm
3. Width of groove: 0.6 or 0.7 mm

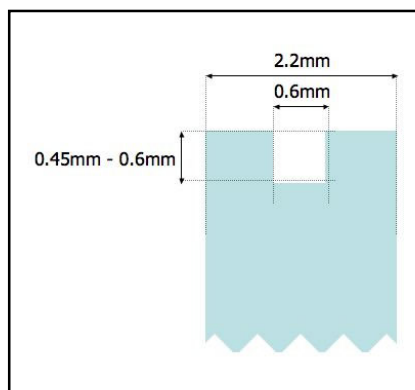

** The above only serves as a recommendation for opticians. Opticians are strongly recommended to contact the lens laboratories for further professional advice.*